

Floor Trim Collection

For use with LVT, wood, ceramic & other modular flooring



GRADUS

Why Gradus

Quality, performance and service are at the heart of everything we do. Founded in 1966, Gradus has over 50 years of extensive knowledge and is the market leader offering the widest choice of flooring accessories.

Gradus are committed to helping you and your customers every step of the way. Whether it's advice on product selection or simply just the assurance of delivering the right product to the right place at the right time, we can offer you complete piece of mind through our dedicated Sales and Technical Support teams should you ever need us.



Gradus is a member of the Contract Flooring Association



Gradus is a member of the RIBA CPD Providers Network



Gradus is a member of NBS Plus

Contents

Our “Floor Trim Collection” showcases selected Gradus profiles ideal for use with LVT or other types of modular flooring such as woods, ceramics and carpet tile.

It encompasses a wide range of trims, to not only provide solutions for common everyday occurrences, but also for those unusual installation scenarios that you may encounter from time to time where a specialist type of trim is needed.

To view the full Gradus range, visit our website at www.gradus.com for more information. Here you’ll find further details on individual profiles and have access to download any supporting literature such as installation instructions and cleaning & maintenance guidelines.

Transition Strips

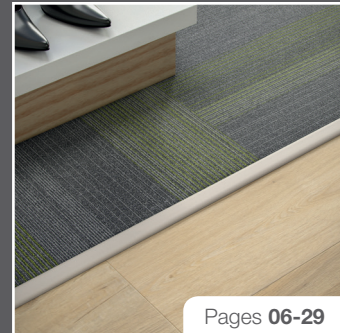

Multi-Purpose Trims

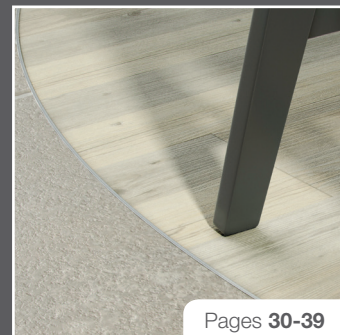

Cover Strips

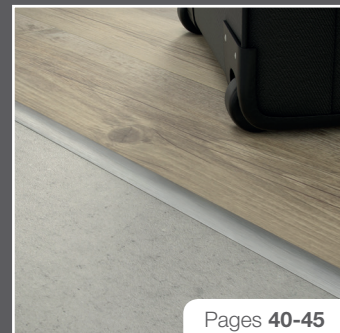

Skirting & Coving

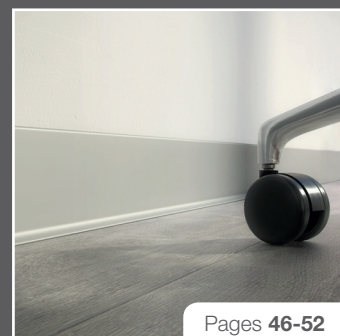

Transition Strips

Luxury Trim System.....	08-09
MTS Multi-Trim System – PVC-u & Aluminium	10-11
Clip-Top	12-13
Clip-Top fx	14-15
Design-Clip	16
PPS System	17
Euro-Clip System	18
Trans-Edge Trims	19
Edge Trims	20
Nap Trims	21
Square Edge Trims	22-23
Finishing Trims	24
Joint Trims	25
Threshold Trims	26
Transition T Profiles	27
Ramp Edges – Pvc & Aluminium	28-29

Multi-Purpose Trims

Aluminium Multi-Purpose Trims.....	32-36
Stainless Steel Multi-Purpose Trims.....	37
Brass Multi-Purpose Trims	38-39

Cover Strips

Stainless Steel Cover Strips	42-44
Brass Cover Strips	44
Aluminium Cover Strips	45

Floor Trims

Floor trims help to reduce the risk of accidents by providing a safe transition between floorcoverings. They can also provide a safe joint where wheeled traffic is expected to ensure that trolleys can move freely between different types and heights of floorcovering.

You'll find a selection of Gradus floor trims in a variety of shapes and sizes to suit an array of floorcoverings ranging from LVT, woods, ceramics and other types of modular flooring.

We understand that selecting the right trim can sometimes be a complex process and it's important to always consider a combination of the safety, performance and aesthetic requirements for your specific application.

What to consider when selecting a Floor Trim?

01 Safety

- The type of environment?
 - Is the area prone to spillages or wet floors?
- If carpet or carpet tile is present, have you considered its compressed thickness?
 - What type of profile is needed – i.e. ramp top, twin top, one-piece or two-piece etc?

02 Performance

- Volume of pedestrian traffic anticipated?
 - Any likelihood of wheeled traffic?
- Cleaning and maintenance regimes expected?
 - Is a gap for natural expansion required?

03 Aesthetics

- Any particular colours, finishes or materials preferred?
- Would you like the floor trim to blend in with the surrounding environment or act as a highlight to define a walkway or breakout area for example?
 - Straight or curved floor trim required (curving diameter requirements)?

Floor Trim Colours

We offer a choice of colours and finishes to suit virtually any environment. Whether it's a premium bronze finish to blend with the surroundings at a 5-star hotel or to act as a highlight within a high-street retail store, Gradus has a colour and finish to suit your specific needs.

Below you can view all the different colours and finishes based on the products featured within this brochure.

Bronze / Brass

Polished Brass / F7 Polished Bronze



Below is a selection of specialist finishes that are applied to a polished brass material.

Polished Chrome Satin Chrome Brushed Stainless Steel Pearl Nickel Satin Nickel



Aluminium

Mill Finish / Natural F0 Natural F3 Polished



Below is a selection of finishes that are applied to aluminium material.

Polished Silver Etched Silver F4 Silver Anodised F5 Gold Anodised



Stainless Steel

F8 Polished F8G Matt



Pvc Standard

Black Brown Granite Bluebell Dove Clay



Pvc Metallics

Burnt Almond Zinc Doubleton Platinum Silver



Wood Finish

H30 - Light Oak H20 - Dark Beech H22 - Light Beech H40 - Maple



These wood effect finishes are applied to aluminium material.

Please note: Due to the limitations of the printing process, colours within this catalogue should not be relied upon for colour matching. An accurate colour match can only be achieved by requesting the relevant product sample(s) from Gradus Technical Support on 01625 428922.

Floor Trim Colour Availability

To find out which colours and finishes are available within each range, please refer to the following colour availability table.

Non-standard colours are also available and special colours can be matched upon request subject to minimum quantity and lead time. For further information contact Technical Support on 01625 428922.

Material	Colour/Finish	Luxury Trim System	CET5, Clip-Top PVC-u Standard, Clip-Top fx, GT61R, Multi-Trim System PVC-u	Multi-Trim System Aluminium	Clip-Top Metallic, GT61M	AJC-F4, Design Clip, ET-EBF4, JT-EBF4, TP-F4	PPS System	Euro-Clip System	ACS38, ACS52, ACT, ANT, CG, TA	ACS441, ACS444, ACS470S, ET367, ET, JT, RT, TH382, TH883	BCT	TH495	CTR, CVT, PCR, T	BCS, ETR-F7, ETR-GF7, TP-F7	ETR-F0, ETR-GF0, ETR-UFO	ETR-GF8, SCSP, SCS-SF8	SCS, SCSM, SCS-SF8G	ACS-F3
Bronze / Brass	Polished Chrome	•																
	Satin Chrome	•																
	Brushed Stainless Steel	•																
	Pearl Nickel	•																
	Satin Nickel	•																
	Polished Brass / F7	•													•			
	Polished Bronze										•							
Aluminium	Polished Silver			•														
	F3 Polished									•								•
	Mill Finish / Natural								•									
	F0 Natural														•			
	Etched Silver			•														
	F4 Silver Anodised					•	•			•								
	F5 Gold Anodised						•											
Pvc Standard	Black		•											•				
	Brown		•											•				
	Granite		•											•				
	Bluebell		•															
	Dove		•											•				
	Clay		•															
Pvc Metallics	Burnt Almond				•													
	Zinc				•							•						
	Doubloon				•							•						
	Platinum				•							•						
	Silver				•							•						
Wood Finish	H30 - Light Oak							•										
	H20 - Dark Beech							•										
	H22 - Light Beech							•										
	H40 - Maple							•										
Stainless Steel	F8 Polished															•		
	F8G Matt																•	

For Trans-Edge trims see page 19 for details of insert types and colour availability.

Transition Strips

Whether it's for use with LVT or a different type of modular floorcovering such as woods, ceramic tile or carpet tile, our transition strips help to reduce the risk of accidents by providing a safe and neat junction.

Gradus offers a comprehensive selection of everyday profiles ranging from our popular Clip-Top, Clip-Top fx, MTS, Euro-Clip, PPS and Trans-Edge ranges, through to more specialist trims designed to suit particular situations that you may only encounter occasionally.

Our range includes profiles in ramp configurations for joining floorcoverings of differing heights, "twin tops" ideal for floorcoverings of the same or similar heights, profiles for installing directly up to skirting and a variety of one-piece or two-piece profiles depending on the amount of flexibility that may be required.

Curving

- Many of the Gradus trims in this section can easily be curved by hand, however some trims require a bending machine.
- To rent, buy or for more information about bending machines please contact Technical Support on 01625 428922.

Key



Can be curved by hand.



Bending machine required.

TT35/AFT15

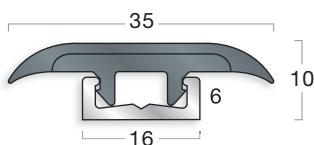

Gradus Clip-Top TT35/AFT15 profile installed at junction between loose lay LVT and carpet tile.

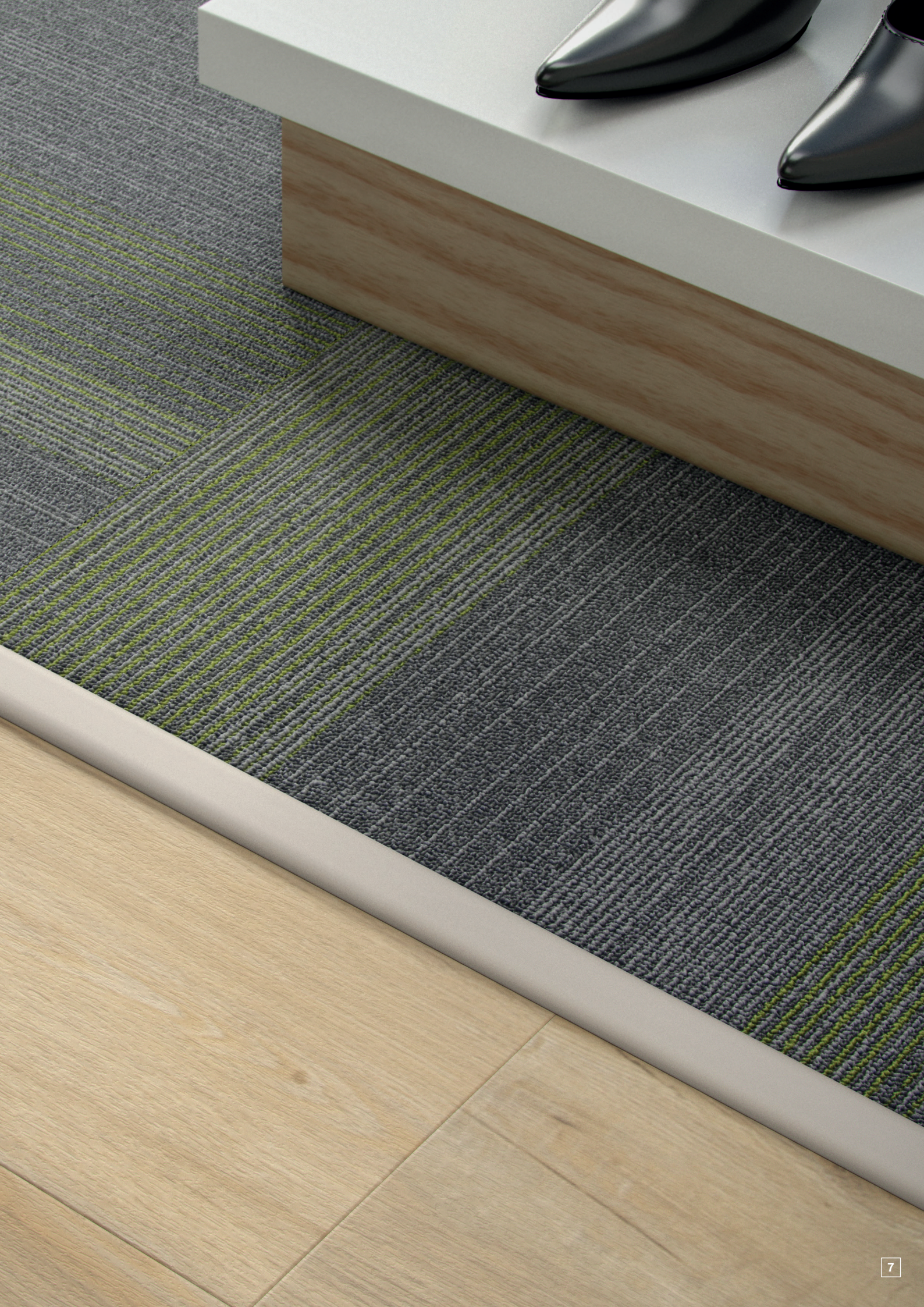

Luxury Trim System

Designed to create an elegant, luxurious appearance within medium traffic applications such as luxury hotels and premium residential developments, these solid brass tops are available in a choice of six premium finishes and are the perfect complement for LVT and other types of modular flooring.

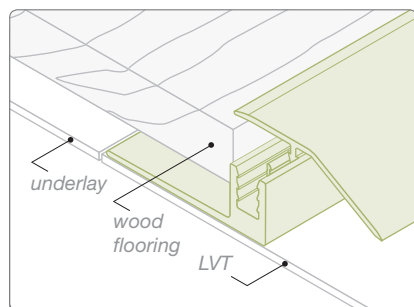

SFBR37/AFT3912 wood flooring to LVT.

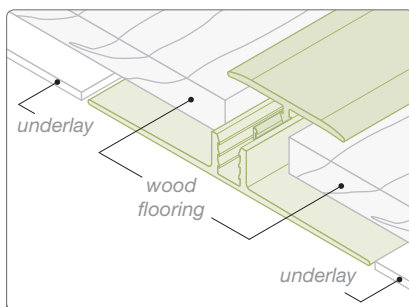

SFBT29/AFT708 wood flooring.

Installation Advice

- Compressed thickness of carpet should always be a tight fit to the internal gauge of the combined top/base
- Where appropriate a suitable gap must be left between the profile base and the flooring to allow for natural expansion
- Bases should always be fitted on top of resilient floorcoverings when used in a ramp configuration
- Bases should be fitted using cartridge adhesive and screw fixings

CODE / PROFILE	MATERIAL	LENGTH	COLOURS / FINISHES
SFBR37 / AFT398 	Brass Top with PVC-u Connector & Aluminium Base Base available with or without carpet gripper	2.715m 0.9m	<ul style="list-style-type: none"> Polished Chrome Satin Chrome Brushed Stainless Steel Pearl Nickel Satin Nickel Polished Brass
SFBR37 / AFT3912 	Brass Top with PVC-u Connector & Aluminium Base Base available with or without carpet gripper	2.715m 0.9m	<ul style="list-style-type: none"> Polished Chrome Satin Chrome Brushed Stainless Steel Pearl Nickel Satin Nickel Polished Brass
SFBR37 / AFT3916 	Brass Top with PVC-u Connector & Aluminium Base Base available with or without carpet gripper	2.715m 0.9m	<ul style="list-style-type: none"> Polished Chrome Satin Chrome Brushed Stainless Steel Pearl Nickel Satin Nickel Polished Brass
SFBT29 / AFT708 	Brass Top with PVC-u Connector & Aluminium Base Base available with or without carpet gripper	2.715m 0.9m	<ul style="list-style-type: none"> Polished Chrome Satin Chrome Brushed Stainless Steel Pearl Nickel Satin Nickel Polished Brass

Dimensions shown are nominal. Illustrations are 70% size in mm. Products subject to minor design alterations without notice.

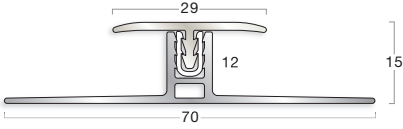
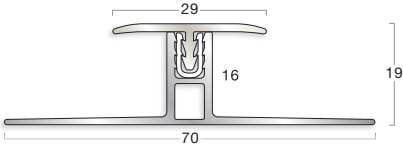
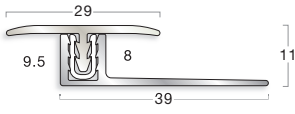
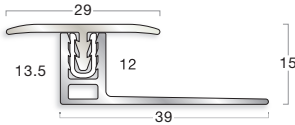
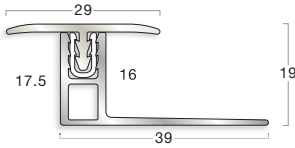

Luxury Trim System

CODE / PROFILE	MATERIAL	LENGTH	COLOURS / FINISHES
SFBT29 / AFT7012 	Brass Top with PVC-u Connector & Aluminium Base Base available with or without carpet gripper	2.715m 0.9m	<ul style="list-style-type: none"> Polished Chrome Satin Chrome Brushed Stainless Steel Pearl Nickel Satin Nickel Polished Brass
SFBT29 / AFT7016 	Brass Top with PVC-u Connector & Aluminium Base Base available with or without carpet gripper	2.715m 0.9m	<ul style="list-style-type: none"> Polished Chrome Satin Chrome Brushed Stainless Steel Pearl Nickel Satin Nickel Polished Brass
SFBT29 / AFT398 	Brass Top with PVC-u Connector & Aluminium Base Base available with or without carpet gripper	2.715m 0.9m	<ul style="list-style-type: none"> Polished Chrome Satin Chrome Brushed Stainless Steel Pearl Nickel Satin Nickel Polished Brass
SFBT29 / AFT3912 	Brass Top with PVC-u Connector & Aluminium Base Base available with or without carpet gripper	2.715m 0.9m	<ul style="list-style-type: none"> Polished Chrome Satin Chrome Brushed Stainless Steel Pearl Nickel Satin Nickel Polished Brass
SFBT29 / AFT3916 	Brass Top with PVC-u Connector & Aluminium Base Base available with or without carpet gripper	2.715m 0.9m	<ul style="list-style-type: none"> Polished Chrome Satin Chrome Brushed Stainless Steel Pearl Nickel Satin Nickel Polished Brass

Dimensions shown are nominal. Illustrations are 70% size in mm. Products subject to minor design alterations without notice.

MTS Multi-Trim System™ – PVC-u & Aluminium

A versatile and simple solution ideal for common interfaces within medium pedestrian and trolley traffic applications such as high street shops, schools, hotels and offices. Available with either PVC-u or aluminium tops, their two-piece construction enables MTS Multi-Trim System to be used with a variety of different floorcoverings including LVT, woods, ceramics and carpet tile.

Installation Advice

- Compressed thickness of carpet should always be a tight fit to the internal gauge of the combined top/base
- When installed with ceramics, wood or wood laminate flooring a suitable gap must be left between the profile base and the flooring to allow for natural expansion
- Bases should be fitted using cartridge adhesive and screw fixings

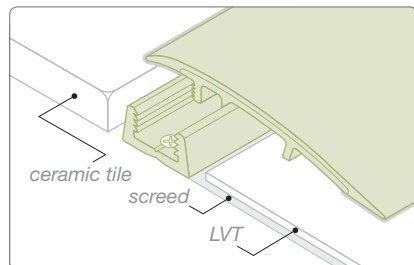

PTR1/MPTB5 ceramic tile to LVT.

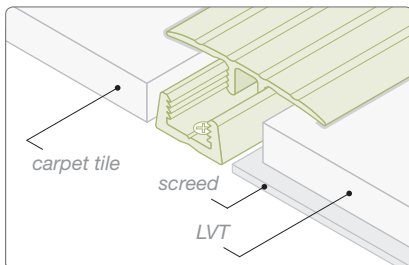

ATT42/PBT12 carpet tile to LVT.

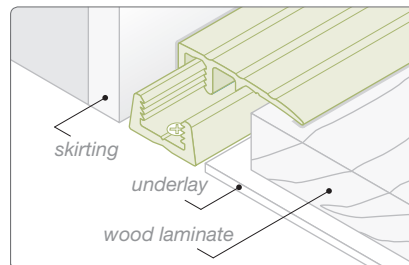

ATB33/PBT12 wood laminate to skirting.

PVC-u:

CODE / PROFILE	MATERIAL	LENGTH	COLOURS / FINISHES
PTT1 / MPTB5 <p>600mm curve on-site Self-levelling</p>	PVC-u Top PVC-u Base	2.70m	<ul style="list-style-type: none"> ■ Black ■ Brown ■ Granite ■ Bluebell ■ Dove ■ Clay
PTT1 / MPTB12 <p>700mm curve on-site Self-levelling</p>	PVC-u Top PVC-u Base	2.70m	<ul style="list-style-type: none"> ■ Black ■ Brown ■ Granite ■ Bluebell ■ Dove ■ Clay
PTT1 / MPTB16 <p>800mm curve on-site Self-levelling</p>	PVC-u Top PVC-u Base	2.70m	<ul style="list-style-type: none"> ■ Black ■ Brown ■ Granite ■ Bluebell ■ Dove ■ Clay
PTR1 / MPTB5 <p>Self-levelling</p>	PVC-u Top PVC-u Base	2.70m	<ul style="list-style-type: none"> ■ Black ■ Brown ■ Granite ■ Bluebell ■ Dove ■ Clay
PTR1 / MPTB12 <p>Self-levelling</p>	PVC-u Top PVC-u Base	2.70m	<ul style="list-style-type: none"> ■ Black ■ Brown ■ Granite ■ Bluebell ■ Dove ■ Clay
PTR1 / MPTB16 <p>Self-levelling</p>	PVC-u Top PVC-u Base	2.70m	<ul style="list-style-type: none"> ■ Black ■ Brown ■ Granite ■ Bluebell ■ Dove ■ Clay

Dimensions shown are nominal. Illustrations are 70% size in mm. Products subject to minor design alterations without notice.



MTS Multi-Trim System™ – PVC-u & Aluminium

Aluminium:

CODE / PROFILE	MATERIAL	LENGTH	COLOURS / FINISHES
ATT42 / PBT12 	Aluminium Top PVC-u Base	2.70m	<ul style="list-style-type: none"> Polished Silver Etched Silver
ATT42 / PBT16 	Aluminium Top PVC-u Base	2.70m	<ul style="list-style-type: none"> Polished Silver Etched Silver
ATB33 / PBT12 	Aluminium Top PVC-u Base	2.70m	<ul style="list-style-type: none"> Polished Silver Etched Silver
ATB33 / PBT16 	Aluminium Top PVC-u Base	2.70m	<ul style="list-style-type: none"> Polished Silver Etched Silver
ATR45 / PBT12 	Aluminium Top PVC-u Base	2.70m	<ul style="list-style-type: none"> Polished Silver Etched Silver
ATR50 / PBT16 	Aluminium Top PVC-u Base	2.70m	<ul style="list-style-type: none"> Polished Silver Etched Silver

Dimensions shown are nominal. Illustrations are 70% size in mm. Products subject to minor design alterations without notice.

Clip-Top™

These two-piece profiles are a great solution for heavy pedestrian and medium wheeled traffic environments including department stores, high street shops, hospitals, schools, hotels and offices. The PVC-u tops can be easily replaced if the colour requires changing, or if a small section ever needs changing, without the disruption of renewing the base or disturbing an existing floorcovering, making these perfect for applications that undergo regular refurbishment programmes.

Installation Advice

- Compressed thickness of carpet should always be a tight fit to the internal gauge of the combined top / base
- Clip-Top bases should always be fitted on top of the resilient floorcovering when used in a ramp configuration
- Bases should be fitted using cartridge adhesive and screw fixings

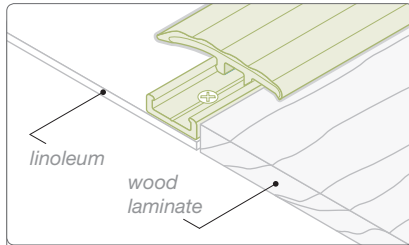

RT35M/AFT13 linoleum to wood laminate.

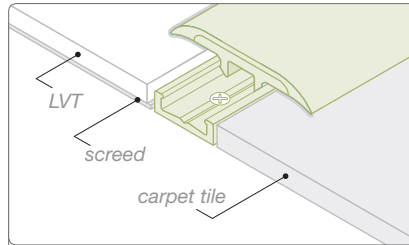

TT35/AFT15 LVT to carpet tile.

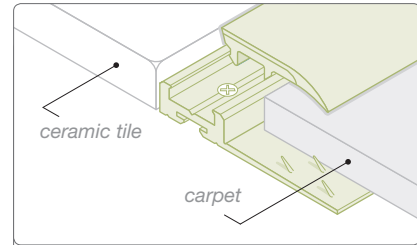

FT27/AFT ceramic tile to carpet.

Curving Clip-Top

Curves between the minimum and maximum radii can be factory fabricated subject to approval of template or detailed drawing (showing radius details) by the Technical Department. Curves greater than the maximum radius can be curved on-site or by Gradus on request. Curves less than the minimum radius cannot be curved.

Tops		
Profile	Min. Radius mm	Max. Radius mm
FT27	250	800
RT35M	1000	3500
RT42	1000	3500
RT52	800	3500
TT25M	500	800
TT35	250	800

Bases		
Profile	Min. Radius mm	Max. Radius mm
AFT12	250	6000
AFT13	250	6000
AFT14	250	6000
AFT15	250	6000
AFT17	250	7000
AFT28	600	9000

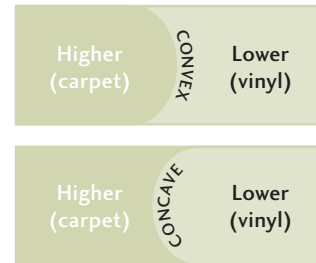

CODE / PROFILE	MATERIAL	LENGTH	COLOURS / FINISHES
TT35 / AFT45 	PVC-u Top Aluminium Base Base available with or without carpet gripper	2.50m	<ul style="list-style-type: none"> ■ Black ■ Brown ■ Granite ■ Bluebell ■ Dove ■ Clay
TT35 / AFT15 	PVC-u Top Aluminium Base Replaceable Tops	2.50m	<ul style="list-style-type: none"> ■ Black ■ Brown ■ Granite ■ Bluebell ■ Dove ■ Clay
TT35 / DFT80 	PVC-u Top Aluminium Base Base available with or without carpet gripper	2.50m	<ul style="list-style-type: none"> ■ Black ■ Brown ■ Granite ■ Bluebell ■ Dove ■ Clay
TT35 / AFT17 	PVC-u Top Aluminium Base Replaceable Tops	2.50m	<ul style="list-style-type: none"> ■ Black ■ Brown ■ Granite ■ Bluebell ■ Dove ■ Clay
TT35 / AFT 	PVC-u Top Aluminium Base Base available with or without carpet gripper	2.50m	<ul style="list-style-type: none"> ■ Black ■ Brown ■ Granite ■ Bluebell ■ Dove ■ Clay

Dimensions shown are nominal. Illustrations are 70% size in mm. Products subject to minor design alterations without notice.

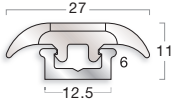
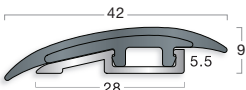
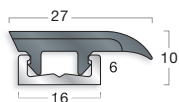

CODE / PROFILE	MATERIAL	LENGTH	COLOURS / FINISHES
TT35 / DFT 	PVC-u Top Aluminium Base Base available with or without carpet gripper	2.50m	<ul style="list-style-type: none"> Black Brown Granite Bluebell Dove Clay
TT25M / AFT14 	Metallic PVC-u Top Aluminium Base Replaceable Tops	2.50m	<ul style="list-style-type: none"> Burnt Almond Zinc Doubleloon Platinum Silver
TT25M / AFT12 	Metallic PVC-u Top Aluminium Base Replaceable Tops	2.50m	<ul style="list-style-type: none"> Burnt Almond Zinc Doubleloon Platinum Silver
RT42 / AFT28 	PVC-u Top Aluminium Base Replaceable Tops	2.50m	<ul style="list-style-type: none"> Black Brown Granite Bluebell Dove Clay
RT52 / AFT28 	PVC-u Top Aluminium Base Replaceable Tops	2.50m	<ul style="list-style-type: none"> Black Brown Granite Bluebell Dove Clay
RT35M / AFT13 	Metallic PVC-u Top Aluminium Base Replaceable Tops	2.50m	<ul style="list-style-type: none"> Burnt Almond Zinc Doubleloon Platinum Silver
FT27 / AFT15 	PVC-u Top Aluminium Base Replaceable Tops	2.50m	<ul style="list-style-type: none"> Black Brown Granite Bluebell Dove Clay
FT27 / AFT45 	PVC-u Top Aluminium Base Base available with or without carpet gripper Replaceable Tops	2.50m	<ul style="list-style-type: none"> Black Brown Granite Bluebell Dove Clay
FT27 / AFT17 	PVC-u Top Aluminium Base Replaceable Tops	2.50m	<ul style="list-style-type: none"> Black Brown Granite Bluebell Dove Clay
FT27 / AFT 	PVC-u Top Aluminium Base Base available with or without carpet gripper Replaceable Tops	2.50m	<ul style="list-style-type: none"> Black Brown Granite Bluebell Dove Clay

Dimensions shown are nominal. Illustrations are 70% size in mm. Products subject to minor design alterations without notice.

Clip-Top fx[®]

Featuring a two-piece design, our Clip-Top fx profiles are suitable for medium pedestrian and wheeled traffic applications including high street shops, schools, hotels and offices. They are particularly suited for applications where a regular refurbishment programme is expected or added flexibility to change tops is preferred. A choice of bases are available with aluminium for straights or PVC-u for curves to allow easy forming on-site without the need for any heat application.

Installation Advice

- Compressed thickness of carpet should always be a tight fit to the internal gauge of the combined top / base
- Clip-Top fx bases should always be fitted on top of the resilient floorcovering when used in a ramp configuration
- Bases should be fitted using cartridge adhesive and screw fixings

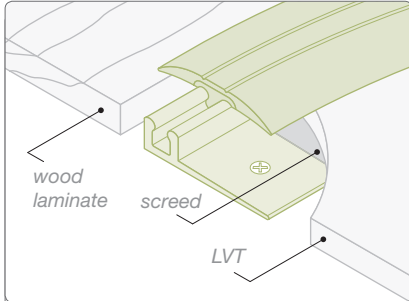

FXT31/FXB336 wood laminate to LVT.

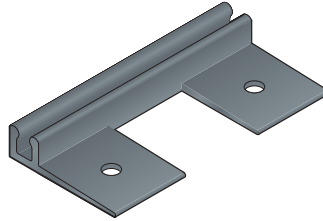

PVC-u bases are pre-punched with tabs and fixing holes for on-site curving. Latex screed should be used with LVT floorcoverings to prevent pre-punched base shadowing through.

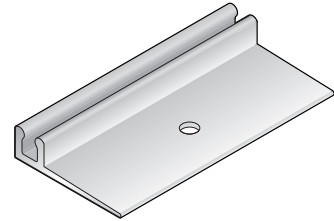











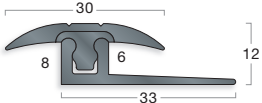

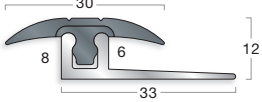

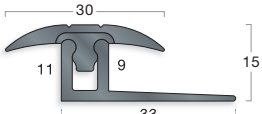

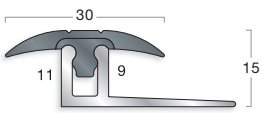

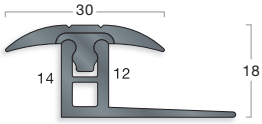
Aluminium bases have a solid flange for straight lengths.

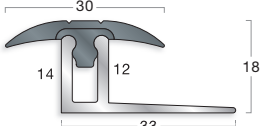
CODE / PROFILE	MATERIAL	LENGTH	COLOURS / FINISHES
FXT21 / FXB336 	 400mm min curve on-site Replaceable Tops	2.50m	<ul style="list-style-type: none"> Black Brown Granite Bluebell Dove Clay
FXT21 / AFT336 	 Replaceable Tops	2.50m	<ul style="list-style-type: none"> Black Brown Granite Bluebell Dove Clay
FXT21 / FXB339 	 400mm min curve on-site Replaceable Tops	2.50m	<ul style="list-style-type: none"> Black Brown Granite Bluebell Dove Clay
FXT21 / AFT339 	 Replaceable Tops	2.50m	<ul style="list-style-type: none"> Black Brown Granite Bluebell Dove Clay
FXT21 / FXB3312 	 400mm min curve on-site Replaceable Tops	2.50m	<ul style="list-style-type: none"> Black Brown Granite Bluebell Dove Clay
FXT21 / AFT3312 	 Replaceable Tops	2.50m	<ul style="list-style-type: none"> Black Brown Granite Bluebell Dove Clay

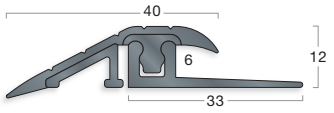
Dimensions shown are nominal. Illustrations are 70% size in mm. Products subject to minor design alterations without notice.

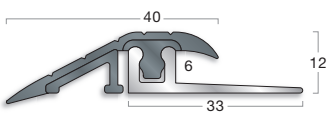

Clip-Top fx®

CODE / PROFILE	MATERIAL	LENGTH	COLOURS / FINISHES	
FXT31 / FXB336 	 400mm min curve on-site  Replaceable Tops	PVC-u Top PVC-u Base	2.50m	<ul style="list-style-type: none"> Black Brown Granite Bluebell Dove Clay
FXT31 / AFT336 	 Replaceable Tops	PVC-u Top Aluminium Base	2.50m	<ul style="list-style-type: none"> Black Brown Granite Bluebell Dove Clay
FXT31 / FXB339 	 400mm min curve on-site  Replaceable Tops	PVC-u Top PVC-u Base	2.50m	<ul style="list-style-type: none"> Black Brown Granite Bluebell Dove Clay
FXT31 / AFT339 	 Replaceable Tops	PVC-u Top Aluminium Base	2.50m	<ul style="list-style-type: none"> Black Brown Granite Bluebell Dove Clay
FXT31 / FXB3312 	 400mm min curve on-site  Replaceable Tops	PVC-u Top PVC-u Base	2.50m	<ul style="list-style-type: none"> Black Brown Granite Bluebell Dove Clay
FXT31 / AFT3312 	 Replaceable Tops	PVC-u Top Aluminium Base	2.50m	<ul style="list-style-type: none"> Black Brown Granite Bluebell Dove Clay
FXR40 / FXB336 	 400mm min convex curve on-site  900mm min concave curve on-site  Replaceable Tops	PVC-u Top PVC-u Base	2.50m	<ul style="list-style-type: none"> Black Brown Granite Bluebell Dove Clay
FXR40 / AFT336 	 Replaceable Tops	PVC-u Top Aluminium Base	2.50m	<ul style="list-style-type: none"> Black Brown Granite Bluebell Dove Clay

Dimensions shown are nominal. Illustrations are 70% size in mm. Products subject to minor design alterations without notice.

Design-Clip

Provides a neat finish at junctions between hard floors such as LVT, wood and wood laminate, whilst also allowing room for natural expansion. Our Design-Clip profiles are suitable for use within medium traffic environments including commercial offices, hotels and restaurants.

Installation Advice

- Bases should be fitted using cartridge adhesive and screw fixings.
- When installed with floorcoverings that require room for natural expansion, a suitable gap must be left between the profile base and the floorcovering to allow for that expansion.

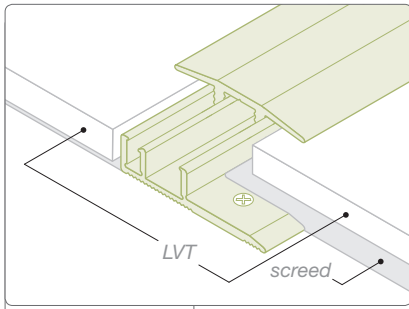

KC578 LVT to LVT.

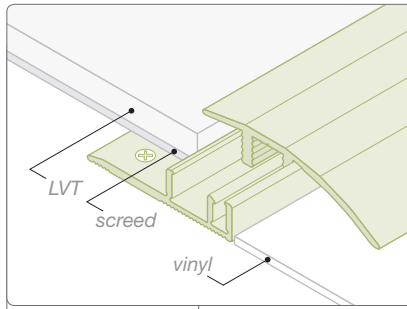

KA576 vinyl to LVT.

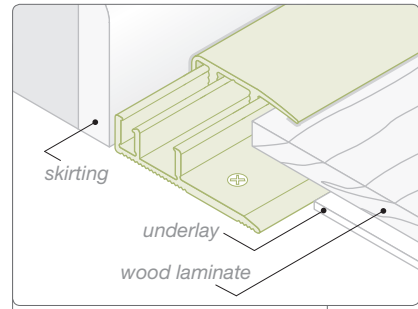

KB577 wood laminate to skirting.

CODE / PROFILE	MATERIAL	LENGTH	COLOURS / FINISHES
KA576 	Aluminium Top Aluminium Base	2.70m	F4 Silver Anodised
KC578 	Aluminium Top Aluminium Base	2.70m	F4 Silver Anodised
NEW KB577 	Aluminium Top Aluminium Base	2.70m	F4 Silver Anodised

Dimensions shown are nominal. Illustrations are 70% size in mm. Products subject to minor design alterations without notice.



PPS® System

These two-piece profiles feature a unique patented linking screw enabling them to accommodate various heights of modular floorcoverings including LVT, whilst also allowing room for natural expansion where necessary. This range is ideal for use within medium traffic applications such as commercial offices and restaurants.

Installation Advice

- Bases should be fitted using cartridge adhesive and screw fixings.
- When installed with floorcoverings that require room for natural expansion, a suitable gap must be left between the profile base and the floorcovering to allow for that expansion.

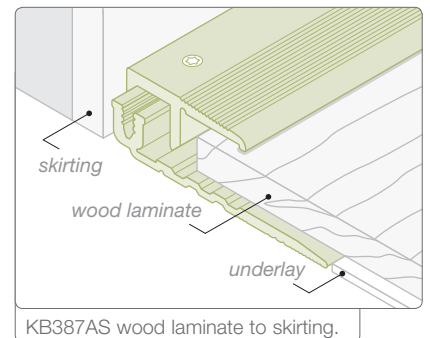
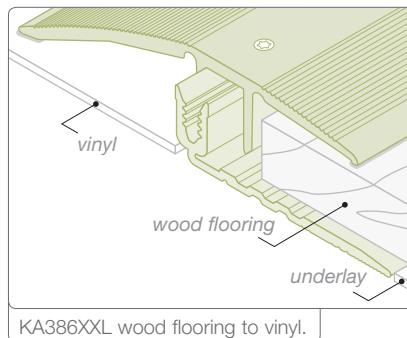
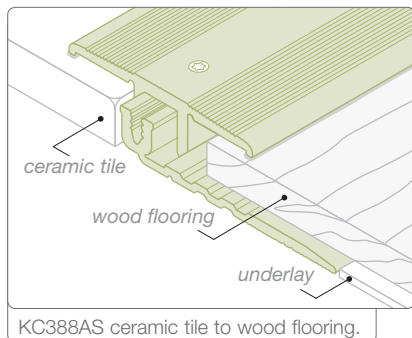

CODE / PROFILE	MATERIAL	LENGTH	COLOURS / FINISHES
KC388AS <p>T10 Torx™ Screw</p> <p>Adjustable height</p>	Aluminium Top Aluminium Base	2.70m	F4 Silver Anodised F5 Gold Anodised
KC388XXL <p>T15 Torx™ Screw</p> <p>Adjustable height</p>	Aluminium Top Aluminium Base	2.70m	F4 Silver Anodised F5 Gold Anodised
KA386AS <p>T10 Torx™ Screw</p> <p>Adjustable height</p>	Aluminium Top Aluminium Base	2.70m	F4 Silver Anodised F5 Gold Anodised
KA386XXL <p>T15 Torx™ Screw</p> <p>Adjustable height</p>	Aluminium Top Aluminium Base	2.70m	F4 Silver Anodised F5 Gold Anodised
KB387AS <p>T10 Torx™ Screw</p> <p>Adjustable height</p>	Aluminium Top Aluminium Base	2.70m	F4 Silver Anodised F5 Gold Anodised
KB387XXL <p>T15 Torx™ Screw</p> <p>Adjustable height</p>	Aluminium Top Aluminium Base	2.70m	F4 Silver Anodised F5 Gold Anodised

Dimensions shown are nominal. Illustrations are 70% size in mm. Products subject to minor design alterations without notice.

Euro-Clip™ System

A range of two-piece wood-effect profiles that enable you to create a coordinating, safe transition and the perfect complement for LVT, wood or wood laminate, allowing room for natural expansion where necessary. Euro-Clip profiles are suitable for use within medium traffic applications such as commercial offices and restaurants.

Installation Advice

- Bases should be fitted using cartridge adhesive and screw fixings.
- When installed with floorcoverings that require room for natural expansion, a suitable gap must be left between the profile base and the floorcovering to allow for that expansion.

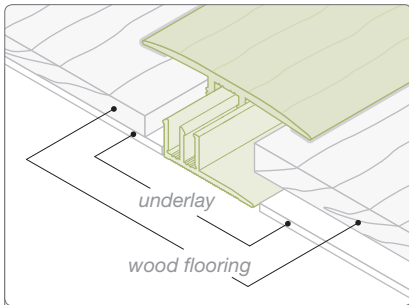

KC588H wood flooring to wood flooring.

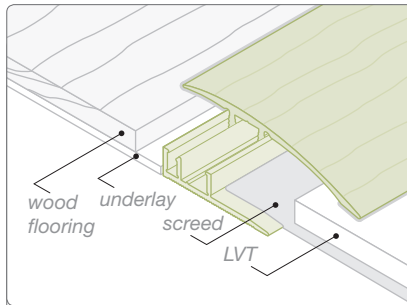

KA586LH wood flooring to LVT.

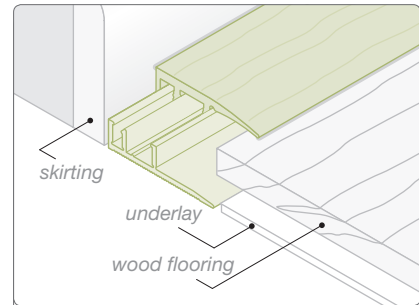

KB587LH wood flooring to skirting.

CODE / PROFILE	MATERIAL	LENGTH	COLOURS / FINISHES
KC588LH 	Aluminium Top Aluminium Base	2.70m	
KC588H 	Aluminium Top Aluminium Base	2.70m	
KA586LH 	Aluminium Top Aluminium Base	2.70m	
KA586H 	Aluminium Top Aluminium Base	2.70m	
KB587LH 	Aluminium Top Aluminium Base	2.70m	
KB587H 	Aluminium Top Aluminium Base	2.70m	

Dimensions shown are nominal. Illustrations are 70% size in mm. Products subject to minor design alterations without notice.



Trans-Edge® – Trims

Designed for the most demanding environments our Trans-Edge range is ideal where frequent heavy foot and wheeled traffic can be expected such as railway stations, airports and hospitals. We offer a choice of Elite inserts depending on the level of slip-resistance needed, Elite standard interior inserts for interior dry conditions or Elite Xtra-grip inserts for interior areas at risk of becoming wet.

Installation Advice

- Aluminium channels are fixed using screws and cartridge adhesive. Elite insert is then fitted into channel to allow concealed fixings
- If used with carpet, compressed thickness of carpet should always be a tight fit to the internal gauge of the profile
- When installed with ceramics, wood or wood laminate flooring a suitable gap must be left between the profile and the flooring to allow for natural expansion
- Ramp profiles should always be fitted on top of resilient floorcoverings

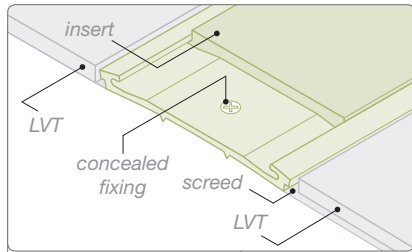

ELACS5040 LVT to LVT.

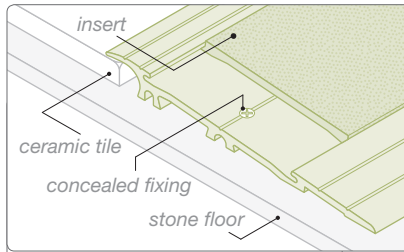

ELAR950 ceramic tile to stone floor.

Elite Insert supplied separately to channel	Coil Length
ELINS30 - Interior	15m coil
ELINS40 - Interior	25m coil
ELINS50 - Interior	25m coil
ELINSXG30 - Xtra-grip	15m coil
ELINSXG50 - Xtra-grip	15m coil

CODE / PROFILE	MATERIAL	LENGTH	COLOURS / FINISHES
ELACS5040 	Aluminium PVC-u Insert (ELINS40)	2.50m See chart above	Elite Xtra-grip Insert ELINSXG All ELAR profiles ■ Onyx ■ Graphite ■ Quarry ■ Ochre Elite Interior Insert ELINS All ELAR & ELACS profiles ■ Jet ■ Coffee ■ Lead ■ Steel □ Snowdrift ELACS5040 ELAR950 ELAR1250 ELAR1550 also available with ■ Ink ■ Burgundy ■ Midnight ■ Evergreen ■ Ocean ■ Poppy ■ Cloud ■ Linen ■ Glacier ■ Canvas ■ Buttercup
ELAR530 	Aluminium PVC-u Insert (ELINS30 or ELINSXG30)	2.50m See chart above	
ELAR830 	Aluminium PVC-u Insert (ELINS30 or ELINSXG30)	2.50m See chart above	
ELAR950 	Aluminium PVC-u Insert (ELINS50 or ELINSXG50)	2.50m See chart above	
ELAR1250 	Aluminium PVC-u Insert (ELINS50 or ELINSXG50)	2.50m See chart above	
ELAR1550 	Aluminium PVC-u Insert (ELINS50 or ELINSXG50)	2.50m See chart above	
ELAR1830 	Aluminium PVC-u Insert (ELINS30 or ELINSXG30)	2.50m See chart above	

Dimensions shown are nominal. Illustrations are 70% size in mm. Products subject to minor design alterations without notice.

Edge Trims

Our Edge Trims are compatible with a huge variety of flooring types including LVT, wood laminate and carpet tile, providing a neat joint between floorcoverings.

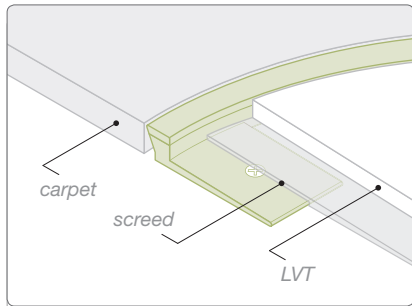

GT61 carpet to LVT.

Key



Pre-punched with tabs and fixing holes for on-site curving.



Solid base for straights.



Solid base with countersunk holes for straights.

CODE / PROFILE	MATERIAL	LENGTH	COLOURS / FINISHES
TA6 	Aluminium	2.75m	Mill Finish
TA8 	Aluminium	3.00m	Mill Finish
ET367 	Aluminium	2.70m	F3 Polished F4 Silver Anodised
GT61M 	pvc Top PVC-u Base	2.50m	Burnt Almond Zinc Doubloon Platinum Silver
GT61R 	pvc Top PVC-u Base	2.50m	Black Brown Granite Bluebell Dove Clay
PET276 	pvc Top PVC-u Base	2.50m	Black Brown Granite Dove

GT/PET profile bases contain up to 25% recycled content.

Dimensions shown are nominal. Illustrations are 70% size in mm. Products subject to minor design alterations without notice.



Nap Trims

Typically used when joining carpet, carpet tile or traditional carpet with underlay to a hard floorcovering such as LVT, wood laminate or ceramics. Nap Trims allow the edges of the carpet to be concealed, resulting in a neat finish and protecting the raw edges.

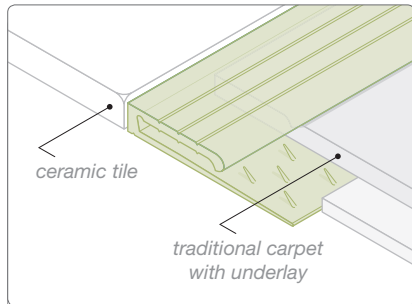

CG1042 ceramic tile to carpet.

Key



Solid base for straights.

CODE / PROFILE	MATERIAL	LENGTH	COLOURS / FINISHES
ANT27 	Aluminium	2.44m 2.75m 3.20m	Mill Finish
ANT355 	Aluminium Available with or without carpet gripper	2.44m 2.75m 3.20m	Mill Finish
CG1042 	Aluminium Available with or without carpet gripper	2.44m 2.75m 3.20m	Mill Finish
BCT16 	Bronze Available with or without carpet gripper	2.50m 2.75m 3.20m	Polished
BCT18 	Bronze Available with or without carpet gripper	2.50m 2.75m 3.20m	Polished

Dimensions shown are nominal. Illustrations are 70% size in mm. Products subject to minor design alterations without notice.

Square Edge Trims

Useful for hiding any slight imperfections in joints or cuts, these profiles are compatible for use with a variety of modular flooring types including LVT, carpet tile, wood and wood laminate at a junction with other flooring materials such as carpet, ceramics and wood. We supply selected profiles with pre-punched bases and tabs for on-site curving as indicated within the table below.

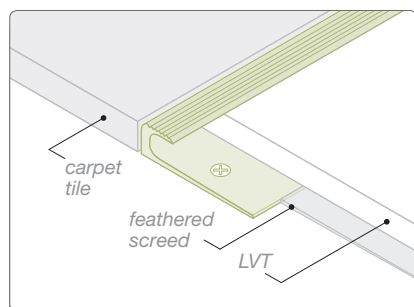

ET804 carpet tile to LVT.

Key



Pre-punched with tabs and fixing holes for on-site curving.



Solid base for straights.













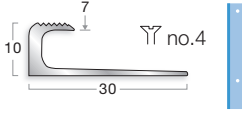

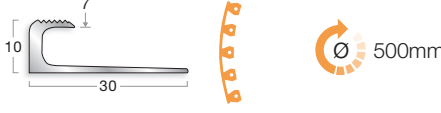

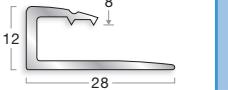
Solid base with countersunk holes for straights.

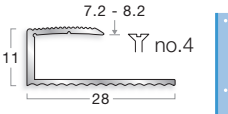
CODE / PROFILE	MATERIAL	LENGTH	COLOURS / FINISHES
NEW ET804 	Aluminium	2.50m	<ul style="list-style-type: none"> F3 Polished F4 Silver Anodised
NEW ET804EBF4 	Aluminium	2.50m	<ul style="list-style-type: none"> F4 Silver Anodised
ET806 	Aluminium	2.50m	<ul style="list-style-type: none"> F3 Polished F4 Silver Anodised
ET806EBF4 	Aluminium	2.50m	<ul style="list-style-type: none"> F4 Silver Anodised

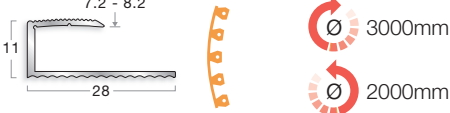
Dimensions shown are nominal. Illustrations are 70% size in mm. Products subject to minor design alterations without notice.

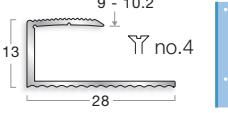

Square Edge Trims

CODE / PROFILE	MATERIAL	LENGTH	COLOURS / FINISHES
ET805 	Aluminium	2.50m	 F3 Polished  F4 Silver Anodised
ET805EBF4 	Aluminium	2.50m	 F4 Silver Anodised
ACT48 	Aluminium Available with or without carpet gripper	3.20m	 Mill Finish
ET210 	Aluminium	2.70m	 F3 Polished  F4 Silver Anodised
ET210EBF4  Bending machine required see page 6	Aluminium	2.70m	 F4 Silver Anodised
ET212 	Aluminium	2.70m	 F3 Polished  F4 Silver Anodised
ET212EBF4  Bending machine required see page 6	Aluminium	2.70m	 F4 Silver Anodised

Dimensions shown are nominal. Illustrations are 70% size in mm. Products subject to minor design alterations without notice.

Finishing Trims

Used to form a neat and clean finish to the edge of a floorcovering where it either finishes or meets another floorcovering. Finishing trims protect the raw edge of floorcoverings, thus extending the life of the floorcovering. In addition, they ensure a safe transition and prevent the edge of the floorcovering from becoming a trip hazard.

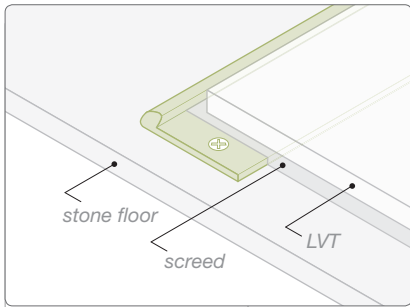

ET356 stone floor to LVT.

Key



Pre-punched with tabs and fixing holes for on-site curving.



Solid base for straights.



Solid base with countersunk holes for straights.

CODE / PROFILE	MATERIAL	LENGTH	COLOURS / FINISHES
ACT61 	Aluminium	2.50m	■ Mill Finish
ACT81 	Aluminium	2.50m	■ Mill Finish
ET356 	Aluminium	2.50m	■ F3 Polished ■ F4 Silver Anodised
ET356EBF4 	Aluminium	2.50m	■ F4 Silver Anodised
ET359 	Aluminium	2.50m	■ F3 Polished ■ F4 Silver Anodised
ET359EBF4 	Aluminium	2.50m	■ F4 Silver Anodised

Dimensions shown are nominal. Illustrations are 70% size in mm. Products subject to minor design alterations without notice.



Joint Trims

Provide a neat junction between two floorcoverings of the same height, for instance where a wood effect LVT meets a mineral effect LVT. These profiles also protect the edges of the floorcoverings and provide a safe transition. Profiles are available pre-drilled with countersunk fixing holes or pre-punched with tabs and fixing holes for on-site curving as indicated within the table below.

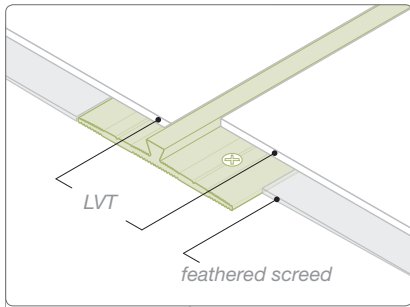

JT365 LVT to LVT.

Key



Pre-punched with tabs and fixing holes for on-site curving.



Solid base with countersunk holes for straights.

CODE / PROFILE	MATERIAL	LENGTH	COLOURS / FINISHES
JT365 	Aluminium	3.00m	F3 Polished F4 Silver Anodised
JT365EBF4 	Aluminium	3.00m	F4 Silver Anodised
JT366 	Aluminium	2.70m	F3 Polished F4 Silver Anodised
JT366EBF4 	Aluminium	2.70m	F4 Silver Anodised

Dimensions shown are nominal. Illustrations are 70% size in mm. Products subject to minor design alterations without notice.

Threshold Trims

Commonly used at door interfaces or when defining changes in areas to create a safe transition, our range of Threshold Trims contains profiles to suit floorcoverings of the same height or slightly differing heights. Threshold Trims provide a neat finish and protect against any damage.

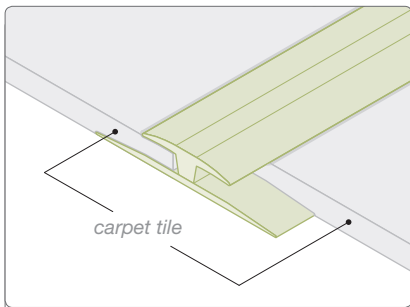

TH495 carpet tile to carpet tile.

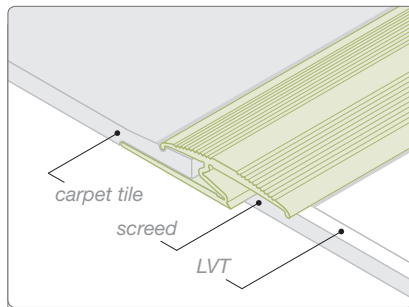

TH382 carpet tile to LVT.

Key



Solid base for straights.



Solid base with countersunk holes for straights.

CODE / PROFILE	MATERIAL	LENGTH	COLOURS / FINISHES
TH382 	Aluminium	2.70m	<ul style="list-style-type: none"> F3 Polished F4 Silver Anodised
	TH382 and TH383 - the top section should be lightly dressed down using a rubber mallet after installation to ensure a tight fit to edges of both floorcoverings.		
TH383 	Aluminium	2.70m	<ul style="list-style-type: none"> F3 Polished F4 Silver Anodised
TH495 	pvc Top PVC-u Base	2.50m	<ul style="list-style-type: none"> Zinc Doubleton Platinum Silver
CET5 	pvc	2.00m	<ul style="list-style-type: none"> Black Brown Granite Bluebell Dove Clay

Dimensions shown are nominal. Illustrations are 70% size in mm. Products subject to minor design alterations without notice.



Transition T Profiles

Designed for joining floorcoverings of the same, or slightly differing, heights, our Transition T profiles allow any slight imperfections to the joints and cuts to be hidden. They allow a gap for natural expansion and can also be curved on-site using a bending machine for shaped edges. To rent, buy or for more information about bending machines, please contact our Technical Support department on 01625 428922. An additional benefit of this range is that it can be fitted after the floorcoverings have already been installed, making these an ideal solution where different trades have installed each floorcovering, e.g. ceramics contractors and flooring contractors.

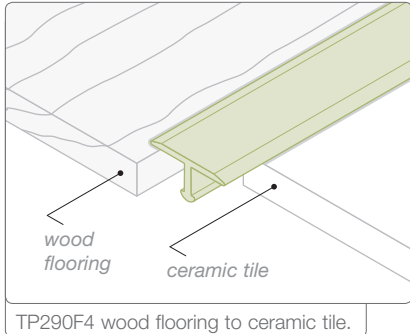

CODE / PROFILE	MATERIAL	LENGTH	COLOURS / FINISHES
<p>TP290F4</p> <p>500mm</p> <p>Aluminium</p> <p>2.70m</p> <p>F4 Silver Anodised</p> <p>Bending machine required see page 6</p>			
<p>TP290F7</p> <p>400mm</p> <p>Brass</p> <p>2.70m</p> <p>F7 Polished</p> <p>Bending machine required see page 6</p>			
<p>TP291F4</p> <p>1200mm</p> <p>1200mm</p> <p>Aluminium</p> <p>2.70m</p> <p>F4 Silver Anodised</p> <p>Bending machine required see page 6</p>			
<p>TP295F4</p> <p>1800mm</p> <p>Aluminium</p> <p>2.70m</p> <p>F4 Silver Anodised</p> <p>Bending machine required see page 6</p>			
<p>TP293F4</p> <p>4000mm</p> <p>Aluminium</p> <p>2.70m</p> <p>F4 Silver Anodised</p> <p>Bending machine required see page 6</p>			

Dimensions shown are nominal. Illustrations are 70% size in mm. Products subject to minor design alterations without notice.

Ramp Edges – Pvc & Aluminium

Ideal for joining a variety of floorcoverings ranging from LVT, woods or carpet tile to floorcoverings of a lower height such as stone, concrete or resilient flooring. Our Ramp Edge profiles ensure a safe transition between floorcoverings and protect the edges to minimise the risk of damage.

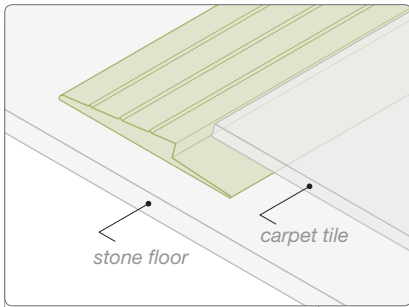

PCR632 carpet tile to stone floor.

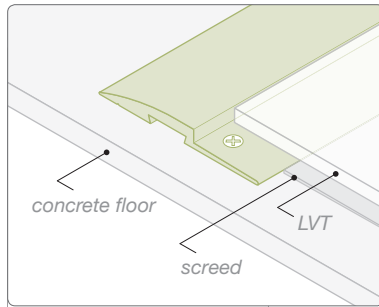

TA16 LVT to concrete floor.

Key



Solid base for straights.



Solid base with countersunk holes for straights.

Pvc:











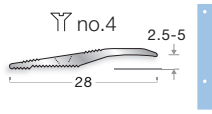

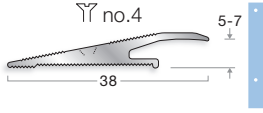

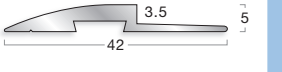
CODE / PROFILE	MATERIAL	LENGTH	COLOURS / FINISHES
CVT5 	pvc	2.00m	<ul style="list-style-type: none"> Black Brown Granite Dove
CTR5 	pvc	2.00m	<ul style="list-style-type: none"> Black Brown Granite Dove
PCR632 	pvc	2.00m	<ul style="list-style-type: none"> Black Brown Granite Dove
PCR932 	pvc	2.00m	<ul style="list-style-type: none"> Black Brown Granite Dove
T450 	pvc	2.00m	<ul style="list-style-type: none"> Black Brown Granite Dove
T600 	pvc	2.00m	<ul style="list-style-type: none"> Black Brown Granite Dove

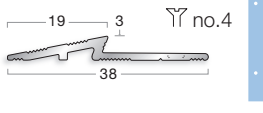
Dimensions shown are nominal. Illustrations are 70% size in mm. Products subject to minor design alterations without notice.

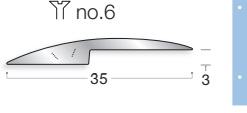

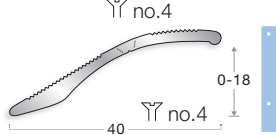
Ramp Edges – Pvc & Aluminium

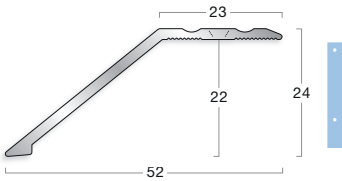
Aluminium:

CODE / PROFILE	MATERIAL	LENGTH	COLOURS / FINISHES
RT264 	Aluminium	2.70m	<ul style="list-style-type: none">  F3 Polished  F4 Silver Anodised
RT265 	Aluminium	2.70m	<ul style="list-style-type: none">  F3 Polished  F4 Silver Anodised
TA16 	Aluminium	2.75m	<ul style="list-style-type: none">  Mill Finish
RT330 	Aluminium	2.70m	<ul style="list-style-type: none">  F3 Polished  F4 Silver Anodised
RT250S 	Aluminium	2.70m	<ul style="list-style-type: none">  F3 Polished  F4 Silver Anodised
RT247 	Aluminium	2.70m	<ul style="list-style-type: none">  F3 Polished  F4 Silver Anodised
RT245 	Aluminium	2.70m	<ul style="list-style-type: none">  F3 Polished  F4 Silver Anodised

Dimensions shown are nominal. Illustrations are 70% size in mm. Products subject to minor design alterations without notice.

Multi-Purpose Trims

Our collection of Multi-Purpose Trims offers incredible versatility with a wide selection of sizes available to suit floorcoverings ranging from LVT to wood flooring.

Featuring a reduced visible surface, these profiles are ideal for areas where a clean, subtle transition is required, allowing the trim to blend in with the surrounding environment and floorcoverings.

Available in a choice of either aluminium, brass or stainless steel finishes, you can choose the trim that best suits your particular application.

Depending on the floorcoverings to be fitted, we offer three base options, which are highlighted next to each profile by the relevant symbol (symbol key can be found on page 32):

- Solid base suitable for straights.
- Pre-punched base with tabs and fixing holes for on-site curving.
- Perforated base with fixing holes for straights and use with ceramics.

ETR303F0

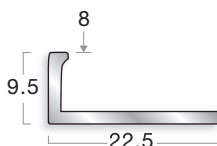

Gradus ETR303F0 Multi-Purpose Trim creating a safe transition between LVT and ceramic tile.



Multi-Purpose Trims

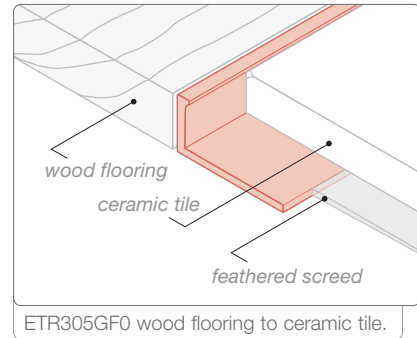
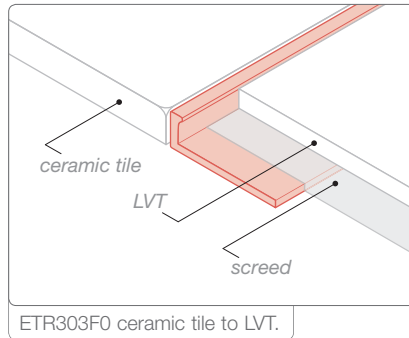
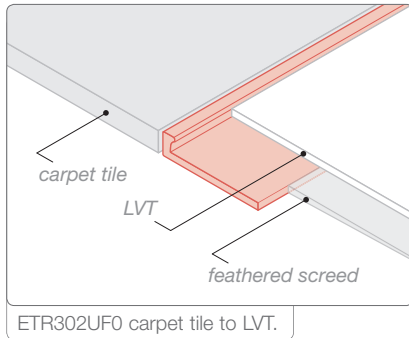

Key



Pre-punched with tabs and fixing holes for on-site curving.



Solid base for straights.



Perforated with fixing holes for straights and use with ceramics.



Can be curved by hand.







Aluminium:

CODE / PROFILE	MATERIAL	LENGTH	COLOURS / FINISHES
ETR299F0 	Aluminium	2.50m	FO Natural
ETR299UF0 	Aluminium	2.50m	FO Natural
ETR299GF0 	Aluminium	2.50m	FO Natural
NEW ETR300F0 	Aluminium	2.50m	FO Natural
NEW ETR300UF0 	Aluminium	2.50m	FO Natural

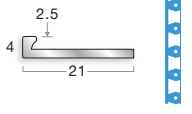
Dimensions shown are nominal. Illustrations are 70% size in mm. Products subject to minor design alterations without notice.

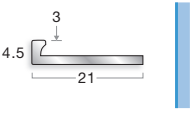
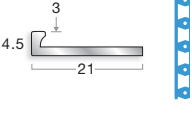

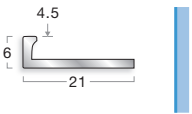
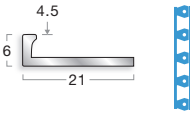

Multi-Purpose Trims

CODE / PROFILE	MATERIAL	LENGTH	COLOURS / FINISHES
NEW ETR300GF0 	Aluminium	2.50m	F0 Natural
ETR301F0 	Aluminium	2.50m	F0 Natural
ETR301UF0 	Aluminium	2.50m	F0 Natural
ETR301GF0 	Aluminium	2.50m	F0 Natural
ETR302F0 	Aluminium	2.50m	F0 Natural
ETR302UF0 	Aluminium	2.50m	F0 Natural
ETR302GF0 	Aluminium	2.50m	F0 Natural
ETR307F0 	Aluminium	2.50m	F0 Natural

Dimensions shown are nominal. Illustrations are 70% size in mm. Products subject to minor design alterations without notice. Symbol key - page 32.

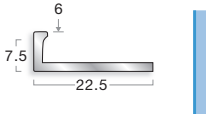
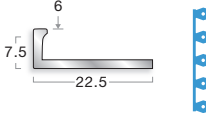

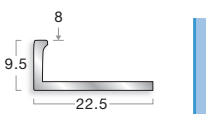
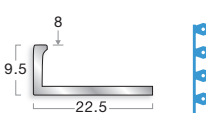
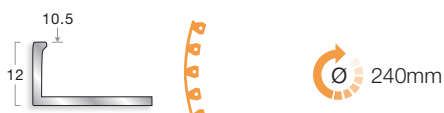
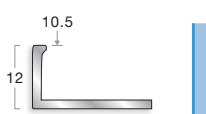

Multi-Purpose Trims

CODE / PROFILE	MATERIAL	LENGTH	COLOURS / FINISHES
<p>ETR307UF0</p> 	Aluminium	2.50m	FO Natural
<p>ETR307GF0</p> 	Aluminium	2.50m	FO Natural
<p>ETR303F0</p> 	Aluminium	2.50m	FO Natural
<p>ETR303UF0</p> 	Aluminium	2.50m	FO Natural
<p>ETR303GF0</p> 	Aluminium	2.50m	FO Natural
<p>ETR304F0</p> 	Aluminium	2.50m	FO Natural
<p>ETR304UF0</p> 	Aluminium	2.50m	FO Natural

Dimensions shown are nominal. Illustrations are 70% size in mm. Products subject to minor design alterations without notice. Symbol key - page 32.

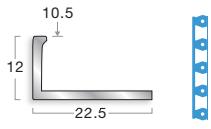

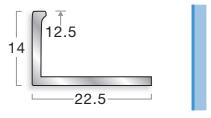
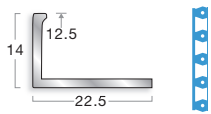

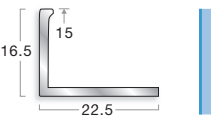
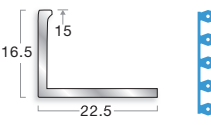
Multi-Purpose Trims

CODE / PROFILE	MATERIAL	LENGTH	COLOURS / FINISHES
ETR304GF0 	Aluminium	2.50m	■ F0 Natural
ETR305F0 	Aluminium	2.50m	■ F0 Natural
ETR305UF0 	Aluminium	2.50m	■ F0 Natural
ETR305GF0 	Aluminium	2.50m	■ F0 Natural
ETR306F0 	Aluminium	2.50m	■ F0 Natural
ETR306UF0 	Aluminium	2.50m	■ F0 Natural
ETR306GF0 	Aluminium	2.50m	■ F0 Natural

Dimensions shown are nominal. Illustrations are 70% size in mm. Products subject to minor design alterations without notice. Symbol key - page 32.

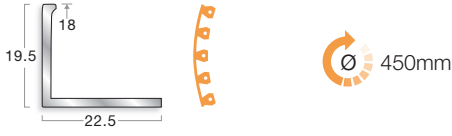
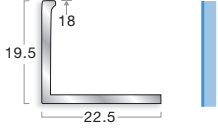
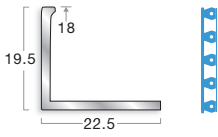
Multi-Purpose Trims

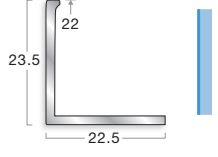
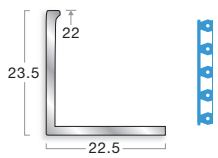
CODE / PROFILE	MATERIAL	LENGTH	COLOURS / FINISHES
NEW ETR312F0 	Aluminium	2.50m	■ F0 Natural
NEW ETR312UF0 	Aluminium	2.50m	■ F0 Natural
NEW ETR312GF0 	Aluminium	2.50m	■ F0 Natural
ETR309F0 	Aluminium	2.50m	■ F0 Natural
ETR309UF0 	Aluminium	2.50m	■ F0 Natural
ETR309GF0 	Aluminium	2.50m	■ F0 Natural

Dimensions shown are nominal. Illustrations are 70% size in mm. Products subject to minor design alterations without notice. Symbol key - page 32.



Multi-Purpose Trims

Stainless Steel:

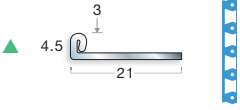
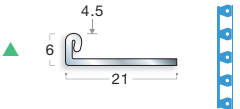
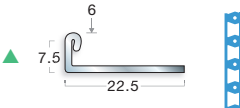
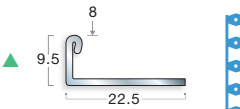
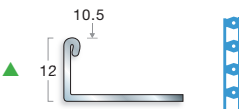
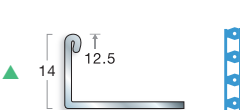
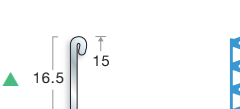
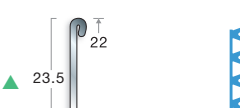





CODE / PROFILE	MATERIAL	LENGTH	COLOURS / FINISHES
ETR301GF8 	Stainless Steel	2.50m	F8 Polished
ETR302GF8 	Stainless Steel	2.50m	F8 Polished
ETR307GF8 	Stainless Steel	2.50m	F8 Polished
ETR303GF8 	Stainless Steel	2.50m	F8 Polished
ETR304GF8 	Stainless Steel	2.50m	F8 Polished
ETR305GF8 	Stainless Steel	2.50m	F8 Polished
ETR306GF8 	Stainless Steel	2.50m	F8 Polished
ETR309GF8 	Stainless Steel	2.50m	F8 Polished

▲ Note there is a +/- 0.5mm tolerance on the height of stainless steel multi-purpose trims.

Dimensions shown are nominal. Illustrations are 70% size in mm. Products subject to minor design alterations without notice. Symbol key - page 32.

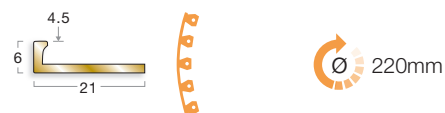
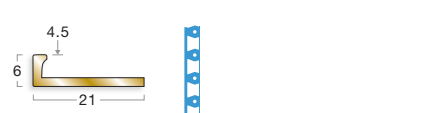
Multi-Purpose Trims

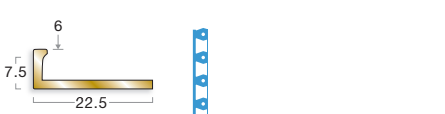

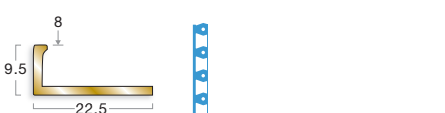

Brass:

CODE / PROFILE	MATERIAL	LENGTH	COLOURS / FINISHES
<p>ETR301F7</p> 	Brass	2.50m	F7 Polished
<p>ETR301GF7</p> 	Brass	2.50m	F7 Polished
<p>ETR302F7</p> 	Brass	2.50m	F7 Polished
<p>ETR302GF7</p> 	Brass	2.50m	F7 Polished
<p>ETR307F7</p> 	Brass	2.50m	F7 Polished
<p>ETR307GF7</p> 	Brass	2.50m	F7 Polished
<p>ETR303F7</p> 	Brass	2.50m	F7 Polished
<p>ETR303GF7</p> 	Brass	2.50m	F7 Polished

Dimensions shown are nominal. Illustrations are 70% size in mm. Products subject to minor design alterations without notice. Symbol key - page 32.

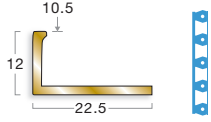

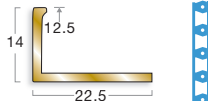
Multi-Purpose Trims

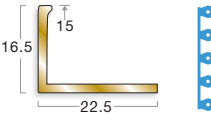
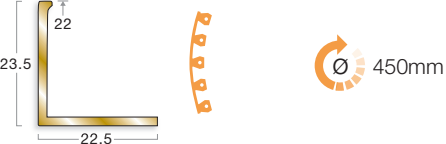
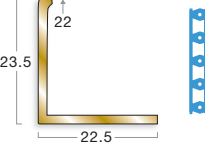
CODE / PROFILE	MATERIAL	LENGTH	COLOURS / FINISHES
ETR304F7 	Brass	2.50m	F7 Polished
ETR304GF7 	Brass	2.50m	F7 Polished
ETR305F7 	Brass	2.50m	F7 Polished
ETR305GF7 	Brass	2.50m	F7 Polished
ETR306F7 	Brass	2.50m	F7 Polished
ETR306GF7 	Brass	2.50m	F7 Polished
ETR309F7 	Brass	2.50m	F7 Polished
ETR309GF7 	Brass	2.50m	F7 Polished

Dimensions shown are nominal. Illustrations are 70% size in mm. Products subject to minor design alterations without notice. Symbol key - page 32.

Cover Strips

Our collection of Cover Strips are designed for joining floorcoverings of a similar thickness and are typically used at door thresholds where two floorcoverings meet.

Not only do they ensure a neat and safe junction between floorcoverings, but they also help to protect the exposed edges of the floorcoverings from damage.

A variety of Cover Strips are available with a choice of central or side-drilled countersunk fixing holes. AJC profiles offer superb flexibility and can also be used as expansion joint covers where required.

Profiles are available in a selection of materials ranging from aluminium, stainless steel and brass, complemented by a great choice of finishes including mill, matt, silver anodised and polished to suit your specific needs.



SCSM451

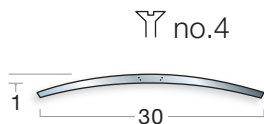

Gradus SCSM451 Cover Strip providing a safe and neat join between two types of LVT.



Cover Strips

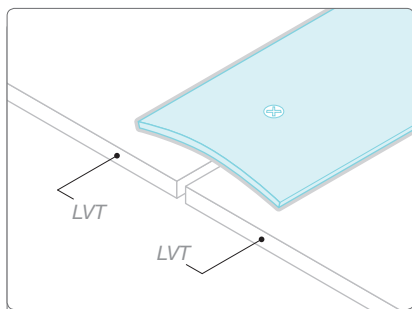

SCSM451 LVT to LVT.

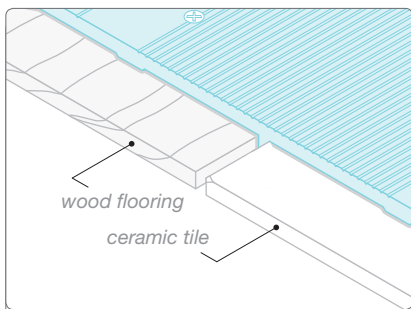

ACS470S wood flooring to ceramic tile.

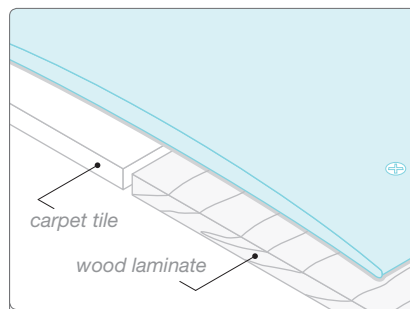

AJC465SF4 carpet tile to wood laminate.

Key



Pre-drilled with central countersunk holes.



Pre-drilled with side countersunk holes.



Pre-drilled with offset countersunk holes.

Stainless Steel:

CODE / PROFILE	MATERIAL	LENGTH	COLOURS / FINISHES
<p>SCSM471</p>	Stainless Steel	2.70m	F8G Matt
<p>SCSP471</p>	Stainless Steel	2.70m	F8 Polished
<p>SCS471SF8G</p>	Stainless Steel	2.70m	F8G Matt
<p>SCS471SF8</p>	Stainless Steel	2.70m	F8 Polished
<p>SCSM451</p>	Stainless Steel	2.70m	F8G Matt

Dimensions shown are nominal. Illustrations are 70% size in mm. Products subject to minor design alterations without notice.

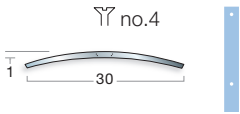
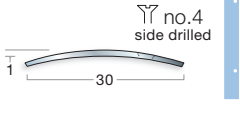
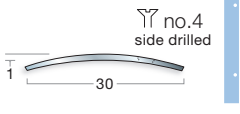
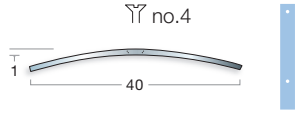
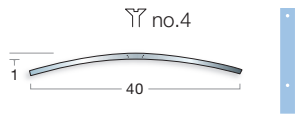
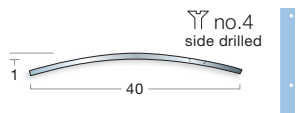
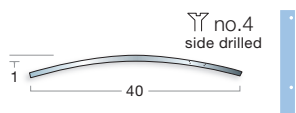
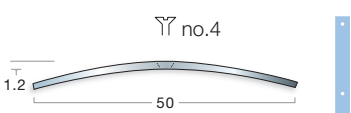
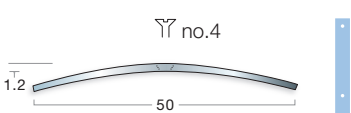

Cover Strips

CODE / PROFILE	MATERIAL	LENGTH	COLOURS / FINISHES
<p>SCSP451</p> 	Stainless Steel	2.70m	F8 Polished
<p>SCS451SF8G</p> 	Stainless Steel	2.70m	F8G Matt
<p>SCS451SF8</p> 	Stainless Steel	2.70m	F8 Polished
<p>SCSM454</p> 	Stainless Steel	2.70m	F8G Matt
<p>SCSP454</p> 	Stainless Steel	2.70m	F8 Polished
<p>SCS454SF8G</p> 	Stainless Steel	2.70m	F8G Matt
<p>SCS454SF8</p> 	Stainless Steel	2.70m	F8 Polished
<p>SCSM455</p> 	Stainless Steel	2.70m	F8G Matt
<p>SCSP455</p> 	Stainless Steel	2.70m	F8 Polished

Dimensions shown are nominal. Illustrations are 70% size in mm. Products subject to minor design alterations without notice.

Cover Strips

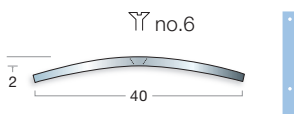
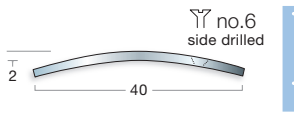
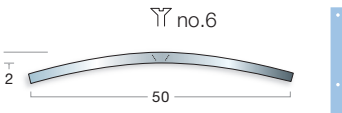
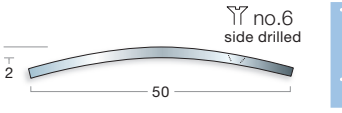
CODE / PROFILE	MATERIAL	LENGTH	COLOURS / FINISHES
SCSM474 	Stainless Steel	2.70m	F8G Matt
SCS474SF8G 	Stainless Steel	2.70m	F8G Matt
SCSM475 	Stainless Steel	2.70m	F8G Matt
SCS475SF8G 	Stainless Steel	2.70m	F8G Matt

Brass:

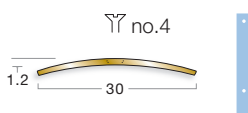
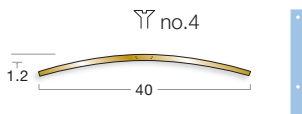
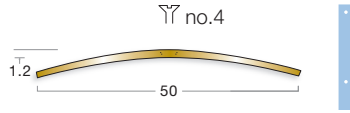
CODE / PROFILE	MATERIAL	LENGTH	COLOURS / FINISHES
BCS452F7 	Brass	2.70m	F7 Polished
BCS454F7 	Brass	2.70m	F7 Polished
BCS455F7 	Brass	2.70m	F7 Polished

Dimensions shown are nominal. Illustrations are 70% size in mm. Products subject to minor design alterations without notice.



Cover Strips

Aluminium:

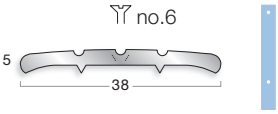
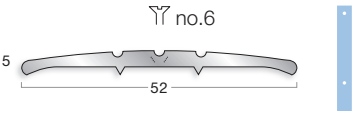
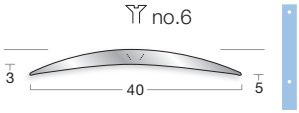
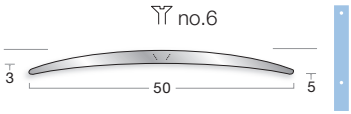
CODE / PROFILE	MATERIAL	LENGTH	COLOURS / FINISHES
ACS38 	Aluminium	2.50m 2.75m	■ Mill Finish
ACS52 	Aluminium	2.50m 2.75m	■ Mill Finish
ACS441 	Aluminium	2.70m	■ F3 Polished ■ F4 Silver Anodised
ACS444 	Aluminium	2.70m	■ F3 Polished ■ F4 Silver Anodised
ACS462F3 	Aluminium	2.70m	■ F3 Polished
ACS463F3 	Aluminium	2.70m	■ F3 Polished
AJC465SF4  <p>ideal for use as an expansion joint cover to allow movement</p>	Aluminium	2.70m	■ F4 Silver Anodised
AJC466SF4  <p>ideal for use as an expansion joint cover to allow movement</p>	Aluminium	2.70m	■ F4 Silver Anodised
ACS470S <p>See below</p>	Aluminium	3.00m	■ F3 Polished ■ F4 Silver Anodised

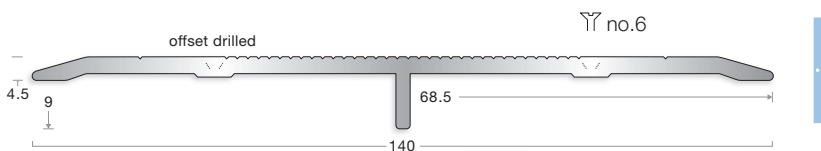

Dimensions shown are nominal. Illustrations are 70% size in mm. Products subject to minor design alterations without notice.



Skirting & Coving

MAS90 Aluminium Skirtings	48
MSS790 Stainless Steel Skirtings	49
MAS95 Interlocking Aluminium Skirtings.....	50
MAS97 Interlocking Aluminium Skirting.....	51
Aluminium Cove Formers	52

Skirting & Coving





Our skirting & cove formers provide a neat, clean and safe solution for junctions where the floor meets the wall. Gradus profiles are the perfect complement for any LVT and other types of modular floorcoverings such as woods, ceramics and carpet tile.

Below are a variety of considerations to help ensure that you select the appropriate skirting or coving profile for the job at hand.

What to consider when selecting a Skirting or Coving?

- The type of environment?
 - The type of floorcovering(s) and the thickness of these?
- Is there a requirement for the floorcovering to continue up the wall?
- Any additional functionality requirements such as concealing cables?
- Number of end caps, junctions, external or internal corners and any other accessories required?
 - Is “wall-to-floor expansion” necessary?
- What specific look you are hoping to achieve?
- Does the skirting ideally need to sit on top of the floorcovering?
 - Is there a particular colour or finish required?

Colour Availability

	MAS90 Range	MAS95 Range	MAS97 Range	MSS790 Range	CVA870IW	CVA927
Metals						
 F4 Silver Anodised Aluminium					•	•
 Silver Anodised Aluminium	•	•	•			
 F6 Bronze Anodised Aluminium					•	
 F9 Sand Anodised Aluminium					•	
 Satin Stainless Steel				•		

F4 Silver Anodised



Silver Anodised



F9 Sand Anodised



F6 Bronze Anodised



Satin Stainless Steel



Please note: Due to the limitations of the printing process, colours within this catalogue should not be relied upon for colour matching. An accurate colour match can only be achieved by requesting the relevant product sample(s) from Gradus Technical Support on 01625 428922.

MAS90 Aluminium Skirtings



These silver anodised aluminium profiles create a modern hi-tech finish and are designed to sit on top of floorcoverings. The capped toe design makes them a great solution for hiding wall-to-floor expansion gaps.

A selection of metal accessories including end caps, junctions and corners are also available for our MAS90 profiles, all supplied in a silver anodised finish to ensure neat and tidy finishing on site.

MAS90 profiles are fixed to the wall using appropriate adhesive.

CODE / PROFILE	FINISHES	LENGTH	END CAPS	JUNCTION	EXTERNAL CORNER	INTERNAL CORNER
MAS90/6SF 	Silver Anodised Aluminium *	2.00m	MAS90/6MP	MAS90/6MG	MAS90/6ME	MAS90/6MI
MAS90/8SF 	Silver Anodised Aluminium *	2.00m	MAS90/8MP	MAS90/8MG	MAS90/8ME	MAS90/8MI
MAS90/10SF 	Silver Anodised Aluminium *	2.00m	MAS90/10MP	MAS90/10MG	MAS90/10ME	MAS90/10MI

* Note: Additional finishes are available on request subject to minimum quantities and lead times.

All accessories are supplied in packs of 4 except for End Caps which are supplied as 4 sets of 2 (one left hand and one right hand).



MSS790 Stainless Steel Skirtings

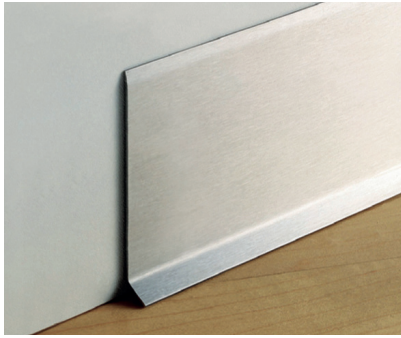

Featuring a stainless steel satin finish, this range is ideal for use in areas where a modern hi-tech finish is required. Designed to sit on top of a variety of floorcoverings, the capped toe design allows wall-to-floor expansion gaps to be hidden.

A choice of metal accessories including end caps, junctions and corners are also available in a satin finish for a consistent look.

MSS790 profiles are fixed to the wall using appropriate adhesive.

CODE / PROFILE	FINISHES	LENGTH	END CAPS	JUNCTION	EXTERNAL CORNER	INTERNAL CORNER
MSS790/6SF 	Stainless Steel Satin Finish	2.70m	MSS790/6MPS	MSS790/6MGS	MSS790/6MES	MSS790/M6IS
MSS790/8SF 	Stainless Steel Satin Finish	2.70m	MSS790/8MPS	MSS790/8MGS	MSS790/8MES	MSS790/M8IS

All accessories are supplied in packs of 4 except for End Caps which are supplied as 4 sets of 2 (one left hand and one right hand).

Dimensions shown are nominal. Illustrations are 70% size in mm. Products subject to minor design alterations without notice.

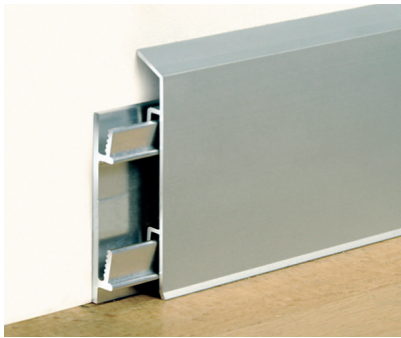

MAS95 Interlocking Aluminium Skirtings



Ideal for use in areas where a modern finish is required, these silver anodised aluminium profiles feature interlocking aluminium brackets and are suitable for most types of modular floorcoverings including LVT, carpet tile, wood, wood laminate and ceramic tiles. The design allows low voltage cables for computers or telephones to be concealed behind the skirting profile and out of view for a clean look.

We offer a variety of accessories such as end caps, junctions and corners in a silver finish PVC-u to co-ordinate with our MAS95 profiles.

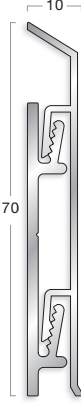
MAS95 profiles are fixed to the wall using screw fixings.

CODE / PROFILE	FINISHES	LENGTH	END CAPS	JUNCTION	EXTERNAL CORNER	INTERNAL CORNER
MAS95/7SF 	Silver Anodised Aluminium with interlocking aluminium fixing brackets	2.00m *	MAS95/7P	MAS95/7G	MAS95/7E	MAS95/7I
MAS95/10SF 	Silver Anodised Aluminium with interlocking aluminium fixing brackets	2.00m *	MAS95/10P	MAS95/10G	MAS95/10E	MAS95/10I

* Note: 3 fixing brackets supplied per length.

All accessories are supplied in packs of 4 except for End Caps which are supplied as 4 sets of 2 (one left hand and one right hand).

Dimensions shown are nominal. Illustrations are 70% size in mm. Products subject to minor design alterations without notice.



MAS97 Interlocking Aluminium Skirting

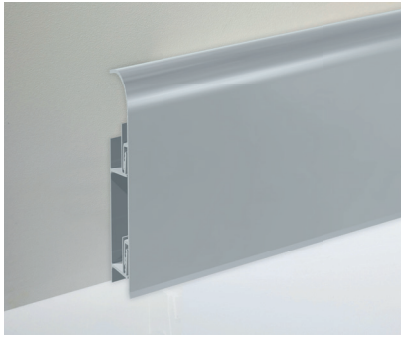

Suitable for use in areas where a modern finish is required, the MAS97 range features a silver anodised aluminium finish to complement a range of modular floorcoverings including LVT, carpet tiles, wood, wood laminate and ceramic tiles. Designed with interlocking aluminium brackets, these profiles are ideal for use within applications where low voltage cables for computers or telephones need to be concealed.

We offer a variety of accessories such as end caps, junctions and corners in a silver finish PVC-u to co-ordinate with this range of profiles.

MAS97 profiles are fixed to the wall using screw fixings.

CODE / PROFILE	FINISHES	LENGTH	END CAPS	JUNCTION	EXTERNAL CORNER	INTERNAL CORNER
MAS97/8SF 	Silver Anodised Aluminium with interlocking aluminium fixing brackets	2.00m *	MAS97/8P	MAS97/8G	MAS97/8E	MAS97/8I

* Note: 3 fixing brackets supplied per length.

All accessories are supplied in packs of 4 except for End Caps which are supplied as 4 sets of 2 (one left hand and one right hand)

Dimensions shown are nominal. Illustrations are 70% size in mm. Products subject to minor design alterations without notice.

Aluminium Cove Formers

Aluminium Cove Formers are perfect for use with LVT as they allow the flooring material to be covered up the wall to create a neat finish where the two meet. Our Aluminium Cove Formers are supplied in two designs with a range of anodised finishes available to complement a wide variety of floorcoverings, making them ideal for premium environments.

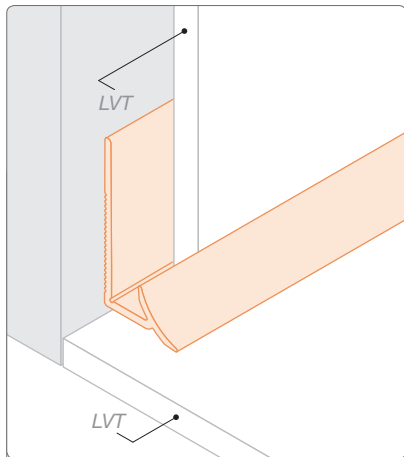

CVA927 coving with 5mm LVT.

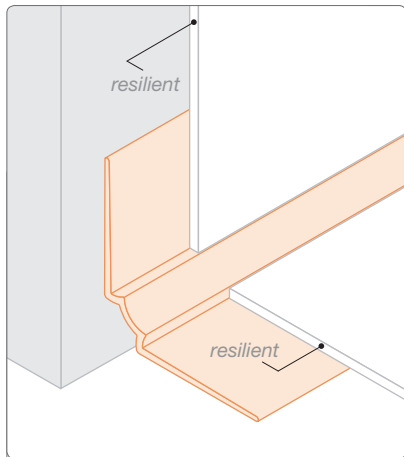

CVA870IW coving with 2.5mm resilient flooring.

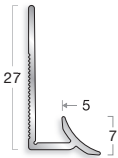
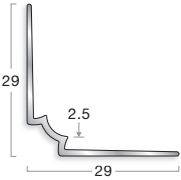
CODE / PROFILE	MATERIAL	LENGTH	COLOURS / FINISHES
NEW CVA927 	Aluminium	2.50m	<ul style="list-style-type: none"> F4 Silver Anodised
NEW CVA870IW 	Aluminium	2.50m	<ul style="list-style-type: none"> F4 Silver Anodised F6 Bronze Anodised F9 Sand Anodised

Dimensions shown are nominal. Illustrations are 70% size in mm. Products subject to minor design alterations without notice.

Find your nearest Gradus distributor:

Download a copy of the latest Gradus Distributor List from our website to find out where your nearest distributor is located.



Order product samples:

Here you can select and save an unlimited number of Gradus products onto your own personal design board before ordering free samples for any products of interest.

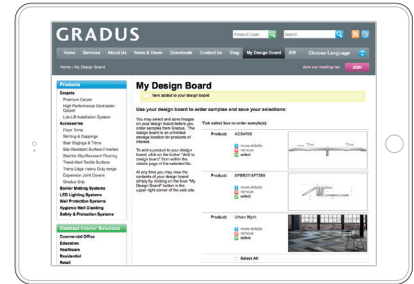

Discover our Gradus Grip flexible adhesive:

Now featuring an upgraded formula, Gradus Grip is a rapid curing flexible adhesive suitable for bonding the majority of Gradus floor trims to most solid surfaces within internal environments.

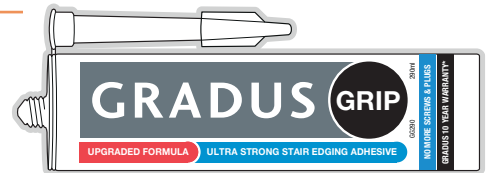

ULTRA STRONG BOND
FOR MOST SURFACES*

SAVE TIME & MONEY

GRADUS 10 YEAR WARRANTY*

NO MORE SCREWS
AND PLUGS

*Further information can be found at www.gradus.com

View the full suite of Gradus product categories and download brochures:

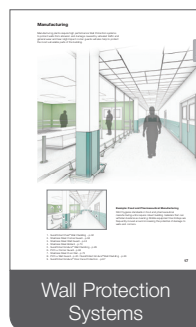
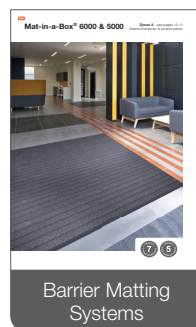

Don't forget to check us out on Social Media:



Follow us on twitter @Gradus_World



Keep up to date with us on LinkedIn – [gradusworld](https://www.linkedin.com/company/gradusworld)



Create your own boards and design ideas on Pinterest – [gradusworld](https://www.pinterest.com/gradusworld)



View some of our installation photography on Flickr – [gradusimagelibrary](https://www.flickr.com/photos/gradusimagelibrary)

GRADUS

Gradus Accessories Park Green Macclesfield Cheshire SK11 7LZ UK Tel: 01625 428922

For enquiries outside the UK and Eire contact Gradus International on +44 (0)1625 613780

call: 01625 428922 **www.gradus.com**



All designs, images and illustrations contained within this catalogue remain the copyright of Gradus Ltd.©
All trademarks, product names and codes detailed within this catalogue are the property of Gradus Ltd.